



RAF-B281

氣炸鍋

Air Fryer



僅供家庭使用
For household use only

使用說明書

OPERATION MANUAL

- 在使用本產品前，請仔細閱讀此說明書，閱讀後小心收藏保存，以備日後查閱。
Please read the operation manual carefully before using. Keep it in a safe place for future reference.
- 本說明書中的圖示可能與實物有不同的地方，僅供參考。
The images in this operation manual are for reference only and may not match with the actual product.

非常感謝您選購樂信牌氣炸鍋，使用前須詳細閱讀本說明書，並保存以備日後參考。



1. 安全注意事項











使用本產品時，必須遵守下列安全預防措施：

下圖表示由於錯誤操作而引起不同程度的危險等級。

 警告 此標誌表示可能造成傷亡。	 注意 此標誌表示可能造成傷害或財產損失。
--	---

以下不同標誌區分各種必須遵守的指示。

 此標誌表示禁止。	 此標誌表示必須遵守。
---	---

 警告	
 為免危險，產品只適用於本說明書註明的用途。切勿將產品或任何部份在室外使用或作其他用途使用。如錯誤操作，可造成傷害及故障。	 切勿與其他高功率的電器共用同一插座；或超額使用電線拖板；或使用220-240V以外的電源，以免電力負荷過重及造成危險。
 切勿讓產品在無人看管或沒有炸籃或食物時運作。切勿連續使用超過1小時，以免造成故障。	 須使用額定電流10A或以上及帶接地線的插座。
 切勿擅自改裝產品或使用非生產商提供的零件進行維修，否則可能造成危險及維修保養將無效。	 切勿在產品加裝定時開關或獨立的遙控系統來操作。
 手濕時切勿接觸、插入或拔除插頭，否則可構成觸電的危險。	 產品使用後必須清潔。切勿把產品、電源線或插頭浸入水中；或被水濺濕，以免造成觸電或火災。
 此產品只供家庭或類似環境使用，如商戶內部、辦事處和其他工作環境的員工廚房區域；旅館、汽車旅館和其他住宿類型的環境。	 經常檢查本產品、炸籃、電源線及插頭，如有損壞，為避免危險，立即停止使用，並聯絡信興電器服務中心有限公司安排檢查及維修。

注意



產品上此符號(左圖)表示使用時表面會變熱,切勿觸摸。



切勿在以下環境使用產品:

- 潮濕或近水的環境;
- 被陽光直接照射、靠近熱源或高溫環境如電焗爐附近;
- 不平穩的表面上;
- 易燃物料或不耐熱物品附近(如枱布、窗簾及毛巾等)。



此產品可供年齡在8歲或以上的兒童及體質、感覺或智力有障礙人士或缺乏經驗和相關知識的人士使用,但他們必須曾接受負責安全人士的監督或指導如何安全地使用產品和理解所涉及的危險。



切勿使用任何物品遮蓋產品表面及排氣口,避免過熱導致故障。



切勿烹調非常油膩或多脂肪的食物及使用煮食油,否則可能導致起火危險。



確保食物、錫紙或烘焙紙沒有接觸到發熱管,以免發生火災。注意錫紙及烘焙紙可能因烹調時間和環境而起火。



確保產品上面、兩側及背面必須保持20厘米的散熱空間及平放,以確保產品保持空氣流通,切勿堵塞排氣口。



確保本產品的電源線沒有貼近機身,否則電源線的絕緣材料或會熔化,造成短路的危險。



可觸及的部件(例如: 外殼、炸籃、烤網、烤鍋、烤架、烤串或發熱管等)在使用過程中可能會變熱。應避免接觸灼熱部分或將您的手與臉接近蒸氣與排氣口,並應使用隔熱手套,以免燙傷。



切勿讓兒童清潔及保養產品,除非兒童是年齡在8歲以上及監督的情況下。監督兒童不可將產品當作玩具。將產品及其電線放於8歲以下兒童不能接觸的地方。



烹調會釋出油脂或有醬汁的食物時,須用錫紙包裹食物,避免因食物濺出的油脂或醬汁接觸發熱管而起火。



切勿將易燃物料或密封容器放入產品中進行烹調。









如產品發生冒煙或起火現象,切勿拉出炸籃,以免因遇上空氣而加大火勢。在安全的情況下,立即拔去電源插頭或關掉屋內電源總開關。待停止冒煙後,才可將炸籃拉出。



如長期不使用,發熱管可能會積聚油漬,再次使用時可能會產生大量油煙,此乃正常現象。

注意

-  切勿在電源線纏結的情況下使用或將電源線懸掛在桌子、櫥櫃的邊緣或讓它接觸發熱的表面，否則會損害電源線。
-  使用中或剛使用後，產品會在排氣口排出高溫蒸氣，須保持安全距離。拉出炸籃時，注意高溫蒸氣和熱氣。
-  在插入或拔除插頭時，應手握穩插頭，不要抓住電源線。
-  不可在電源線上放重物、夾住、改裝、用力拉扯或扭曲電源線。
-  切勿使用有殘缺或鬆動的插座。使用前，確保插頭已充分擦乾及已插緊。
-  使用後，從電源插座拔出插頭及待產品冷卻後才移動、清潔或檢查。

2. 清潔及儲存

- 清潔前，必須將產品關掉，拔除電源插頭及待其完全冷卻。取出炸籃，可讓產品更快冷卻。
- 清洗配件如炸籃、烤網、烤鍋、烤架及烤串時，使用溫和清潔劑及海綿等軟性物料，用水沖洗後再抹乾及放回原位。
- 如有食物黏在炸籃、烤網、烤鍋、烤架及烤串，可將配件放在炸籃內，加入混有溫和清潔劑的熱水浸泡10分鐘，再清洗及抹乾。
- 每次使用後，必需清潔產品內腔及配件，避免油脂或食物渣滓積聚導致使用時產生油煙、引起火災或造成侵蝕生銹。可用微濕軟抹布清潔產品機身內外，然後擦乾。
- 切勿使用有毒或含腐蝕性的清潔劑或粗糙的潔具(如鋼絲刷)來清洗。
- 炸籃、烤網及烤鍋屬於消耗品，操作不當或經長時間使用，皆有可能造成塗層損耗，此屬正常現象。
- 缺乏適當清潔產品，會使產品表面劣化，縮短產品的使用壽命及可能會造成危險。
- 儲存時，切勿將電源線纏繞在產品四周或壓住電源線，以免造成電源線損壞，並須將產品放入紙箱及放置在乾爽的環境中。

3. 產品規格

型號	RAF-B281/*
顏色	G = 森林綠 / B = 忌廉白
額定電壓	220-240 伏特~ 50-60 赫茲
額定功率	1,200 瓦
容量 (約)	2.7 升
淨重 (約)	3.6 公斤
產品尺寸 (闊x 深 x 高) (約)	215 x 280 x 267 毫米

4. 產品說明

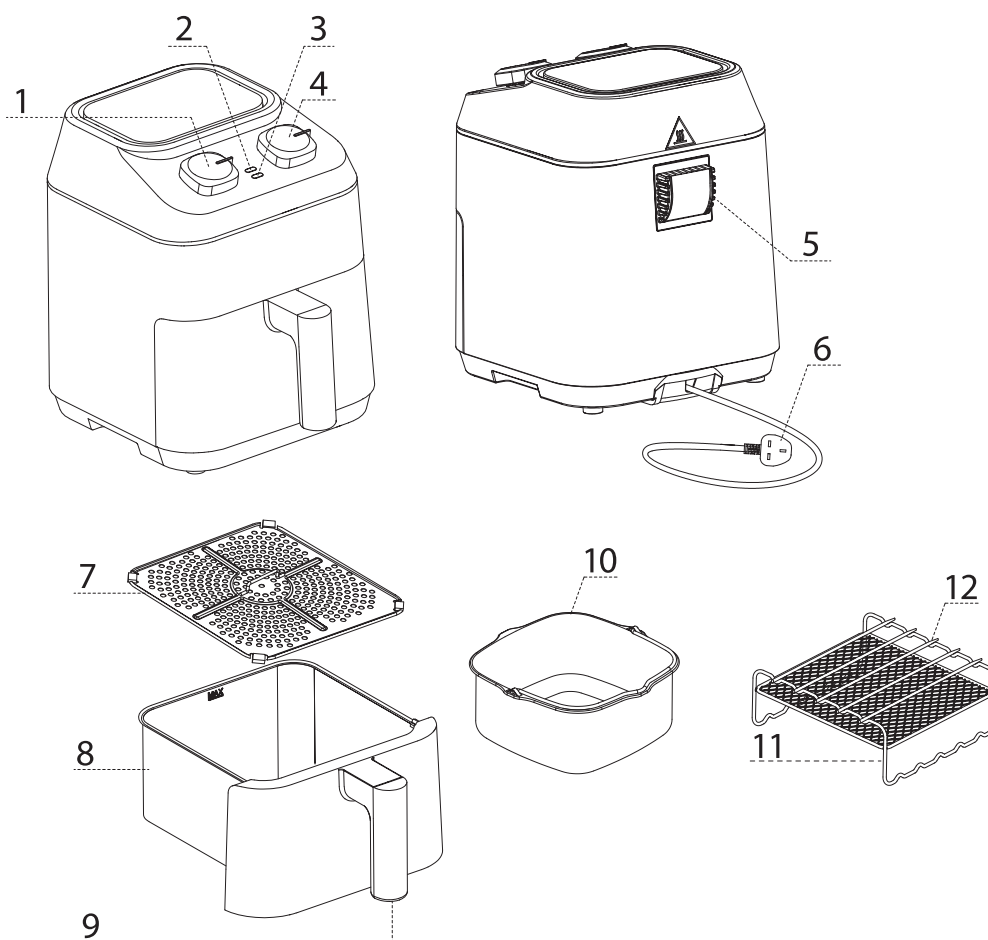

(產品圖像僅用作說明用途，可能與實際產品有所不同。)

- | | |
|----------|---------|
| 1. 溫控器旋鈕 | 7. 烤網 |
| 2. 加熱指示燈 | 8. 炸籃 |
| 3. 電源指示燈 | 9. 炸籃手柄 |
| 4. 時間掣旋鈕 | 10. 烤鍋 |
| 5. 排氣口 | 11. 烤架 |
| 6. 電源插頭 | 12. 烤串 |

5. 首次使用前

1. 除去所有包裝物料及產品上的所有貼紙。
2. 將所有配件清洗乾淨，再用布抹乾。
3. 用微濕布抹淨產品內外，再抹乾。

6. 使用方法

6.1 基本操作

1. 拉出炸籃，將烤網放入炸籃。
2. 將食物放在烤網上，切勿超出炸籃的MAX刻度。
3. 將炸籃推回主機直至壓緊，否則產品不會加熱。
4. 將電源插頭插入插座，電源指示燈亮起。
5. 轉動溫控旋鈕設定所需的烹調溫度，溫度設定範圍為80- 200°C。
6. 轉動時間旋鈕設定所需的烹調時間，時間設定範圍為0-60分鐘。
7. 設定烹調溫度及時間後，加熱指示燈亮起。
8. 當完成烹調，時間旋鈕會轉到“0”的位置。產品會發出叮一聲，將溫控旋鈕轉到“0”的位置以關掉產品。
9. 使用後，將電源插頭從插座拔出。

6.2 配件使用方法

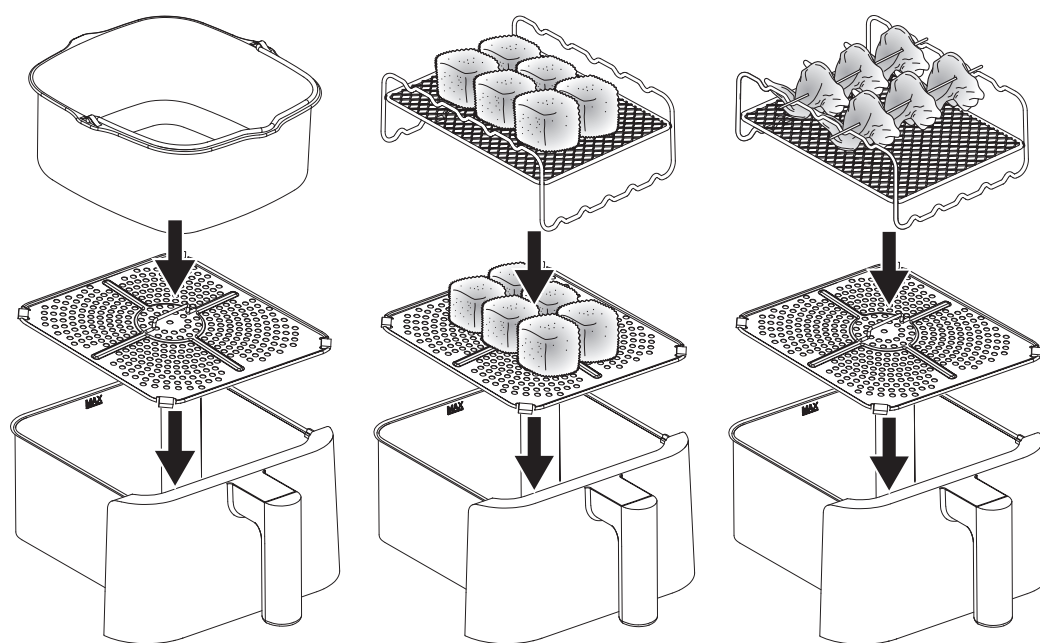

1. 烤鍋 – 將食物放在烤鍋內，再將烤鍋放在烤網上。
2. 烤架 – 將較低的烤架手柄朝上放在烤網上。烤架上下層均可放置食物。
3. 烤串 – 將較高的烤架手柄朝上放在烤網上，再將串好食物的烤串放在烤架上。

6.3 烹調注意事項

1. 在烹調前，可預熱5分鐘，以達致最佳的烹調效果。預熱時，可能會有煙、氣味及發出聲響，此屬正常現象。
2. 烹調時間會因食物的溫度、種類、份量、形狀等不同而各有差異，需根據實際情況進行調整。
3. 時常留意烹調中的食物，避免烤焦。切勿烹調輕量食物，以免烹調時被吹起，導致故障及起火危險。
4. 為減少丙烯酰胺的產生，切勿以過高的溫度及過長時間烹調食物。
5. 烹調過程中如有需要可翻動食物，以達到更均勻的烹調效果。
6. 冷凍過的食物需要較長的烹調時間，需根據實際烹調情況調整烹調時間及溫度。
7. 烹調時，水蒸氣可能會凝聚於產品周邊。這是由於食物當中的水分蒸發所造成，此屬正常現象。
8. 為調整產品內溫度，當產品達到預設溫度時，發熱管會暫時停止加熱，待產品溫度下降後便會恢復運作，加熱指示燈會隨發熱管開關而間斷地亮起。溫度設定以廠方生產規格為準。
9. 使用時，產品可能有聲音發出，這是由於加熱時物料和食物膨脹，並不表示發生故障。

7. 故障排除

故障現象	原因	解決方法
1. 產品不能運作。	- 產品未有插上電源插頭或插頭插不緊。	- 重新將插頭插入插座中。
	- 未有轉動時間旋鈕設定烹調時間。	- 轉動時間旋鈕設定烹調時間。
	- 炸籃未安裝好。	- 將炸籃推回主機直至壓緊。
2. 食材烤焗得不均勻。	- 食材重疊。	- 烹調過程中可翻動食物，以達到更均勻的烹調效果。
3. 食材沒有全熟。	- 食材太多。	- 減少烹調食物的份量。
	- 烹調溫度太低。	- 將烹調溫度調高。
	- 烹調時間太短。	- 再次將食物放入產品烹調。
4. 炸籃不能順利推回產品中。	- 炸籃中盛裝多於MAX刻度的食材。	- 減少食物，炸籃內的食物不可超過MAX 刻度。
	- 炸籃位置不正確。	- 重新將炸籃推回產品直至壓緊。
5. 產品冒出白煙。	- 正在烹調的食物過份油膩。	- 切勿烹調過份油膩食物。

如使用以上方法仍未能解決故障，立即停止使用，並聯絡信興電器服務中心有限公司進行檢查及維修。

8. 特別聲明

1. 此說明書所有內容經過核對，如有任何印刷錯誤或內容上的誤解，本公司將保留解釋權。
2. 本產品若有技術改進，會編進新版說明書中，恕不另行通知；產品外觀及規格以廠方生產資料為準。
3. 此說明書的電子副本可透過電子郵件發送致客戶。如有需要，請致電2861 2767聯絡信興電工工程有限公司。



9. 售後服務

信興電工工程有限公司(“本公司”)將授權信興電器服務中心有限公司(“服務中心”)(統稱“信興”)提供一年保修服務並由發票/換購收據上的日期起計。服務中心保留所有更改保修條款的權利，恕不另行通知，有關保修條款詳情，可參閱本公司網站。



Thank you for choosing Rasonic air fryer. Please read the operation manual carefully before use and keep it for your future reference.

1. Important Safeguards







When using the appliance, must follow the below safety precautions:
The following chart indicates the degree of damage caused by wrong operation.

 WARNING Indicates that may cause death or severe injury.	 CAUTION Indicates hazards that may cause human injuries or property damages.
--	--

The following symbols can distinguish the instruction types that need to be strictly followed.

 These symbols mean prohibition.	 These symbols mean requirement that must be followed.
--	--

WARNING

-  To avoid danger, use the appliance only as described in the operation manual. Do not use it or any part of the appliance outdoors or out of the intended purpose. Misuse can cause potential injury and malfunction.
-  Do not use the same socket with other high power consumption appliance or use the extension cord beyond its capacity or use the power supply other than 220-240V~ to avoid danger caused by overload.
-  Never leave the appliance unattended when in use or operate without the fryer basket or food inside. Do not use continuously over one hour.
-  Ensure the appliance is connected to an earthed socket with rated current 10A or above.
-  Do not attempt to modify the appliance by yourself or repair with any unauthorized parts, otherwise it will cause hazards and the warranty will become invalid.
-  The appliance is not intended to be operated by means of an external timer or separate remote control system.

WARNING



Do not touch, plug in or remove the plug with wet hands, it can cause electric shock.



Clean the appliance after use. Must not immerse the appliance, power cord or plug in water or let them wet, it can cause electric shock or fire.



The appliance is intended to be used in household and similar applications such as staff kitchen in shops, offices and other working environments; by clients in hotels, motels and other residential type environments.



Always check the condition of the appliance, fryer basket, power cord and plug. If any parts is damaged, stop using the appliance immediately to avoid hazard and contact Shun Hing Electric Service Centre Limited to check and repair.

CAUTION



This symbol (shown on the left) on the appliance means the surfaces are liable to get hot during use, do not touch.



Make sure the power cord is not in contact with the appliance enclosure. Otherwise, insulating material of the power cord may melt resulting in a risk of short circuit.



Do not operate the appliance in following places:









- Near humid environment or water;
- Expose to sunlight, near heat sources or high temperature place such as near an electric oven;
- On unstable surface;
- Near flammable or non-resistant to heat objects (e.g. table cloth, curtain and towel etc.).



The temperature of accessible surfaces (such as the enclosure, fryer basket, fryer basket rack, baking pan, grill rack, skewers or heating element, etc.) may be high when the appliance is operating. Care should be taken to avoid touching heated parts or getting your face or hands close to the steam and exhaust vent. Always wear the oven gloves to avoid getting burns.



CAUTION

-  This appliance can be used by children aged from 8 years and above and persons with reduced physical, sensory or mental capabilities or lack of experience and knowledge, if they have been given supervision or instruction concerning use of the appliance in a safe way and understand the hazards involved.
-  Cleaning and user maintenance shall not be made by children unless they are older than 8 and supervised. Children being supervised not to play with the appliance. Keep the appliance and its power cord out of reach of children less than 8 years.
-  Do not cover the appliance surface and exhaust vent with any objects, so as not to cause appliance malfunction.
-  When cooking goods which are greasy or marinated with sauce, must wrap the food with aluminum foil. It is to avoid the food grease or sauces from spilling onto the heating elements and cause fire.
-  Do not frying fat and use cooking oil, as it may cause a fire hazard.
-  Never put inflammable materials or sealed containers into the appliance for cooking.
-  Make sure food, aluminum foil or baking paper does not touch the heating elements to avoid fire. Note that the aluminum foil and baking paper could start a fire depending on the cooking time and conditions.
-  If the appliance smoke or catch fire, should not pull out the fryer basket as air will trigger the fire to burn more vigorously. Unplug it from the power socket at once or turn off the main switch under a safe situation. Wait for the smoke emission to stop before you pull the fryer basket out of the appliance.



CAUTION



Make sure there is at least 20cm clearance on the top, sides and back for good ventilation and the appliance must be placed level. Do not block the exhaust vent.



If the appliance is not in use for a period, grease may accumulate on the heating element. Excessive smoke may occur when it is used again which is normal.



Do not operate the appliance when the power cord is tangled or hang over the edge of a table, counter-top or let it touch any hot surface, it may damage the power cord.



During or immediately after use, the appliance will emit hot steam at the exhaust vent, must keep a safe distance. When pulling out the fryer basket, also pay attention to hot steam and heat.



Grasp the plug itself when plug in or unplug the appliance, do not grasp the power cord.



Do not place heavy objects on the power cord. Never clip, modify, stretch or twist the power cord.



Do not use deficient or loosen socket. Before use, make sure the plug is dry and inserted firmly.



Unplug the appliance after use and let the appliance cool down before moving, cleaning or checking.

2. Cleaning and Storage

1. Before cleaning, must turn off the appliance, unplug the power plug and let it cool down completely. Take out the fryer basket to let the appliance cool down more quickly.
2. When clean the accessories such as fryer basket, fryer basket rack, baking pan, grill rack and skewers, use mild detergent and soft material such as sponge, rinse them and wipe them dry, then place it back to the original position.
3. If food residual sticks on the fryer basket, fryer basket rack, baking pan, grill rack and skewers, put the accessories into the fryer basket, fill it with hot water and mild detergent to soak for approximately 10 minutes, then rinse and wipe them dry.
4. After each use, must clean the cavity and accessories to avoid smoke, fire or metal erosion caused by the accumulated grease or food residue. And the surface and cavity of the appliance can be cleaned by a wrung soft cloth, then wipe it dry.
5. Never use poisonous or corrosive detergent or harsh cleaning tools (e.g. metal-wired brush) to clean.
6. Fryer basket, fryer basket rack and baking pan are consumable part. Misuse or using for a long time, their coating may wear and tear, which is normal.
7. Lack of proper cleaning, the appliance surface will be degraded to shorten the product life and dangers may occur.
8. When store, never wrap the power cord around the appliance or clip the power cord, it is to prevent the power cord from deterioration. Put the appliance into a box and store in a dry place.

3. Product Specifications

Model	RAF-B281/*
Color	G = Forest Green / B = Cream beige
Rated voltage	220-240V~ 50-60Hz
Rated power	1,200 W
Capacity (Approx.)	2.7 L
Net weight (Approx.)	3.6 kg
Product size (W x D x H) (Approx.)	215 x 280 x 267 mm

4. Product Descriptions

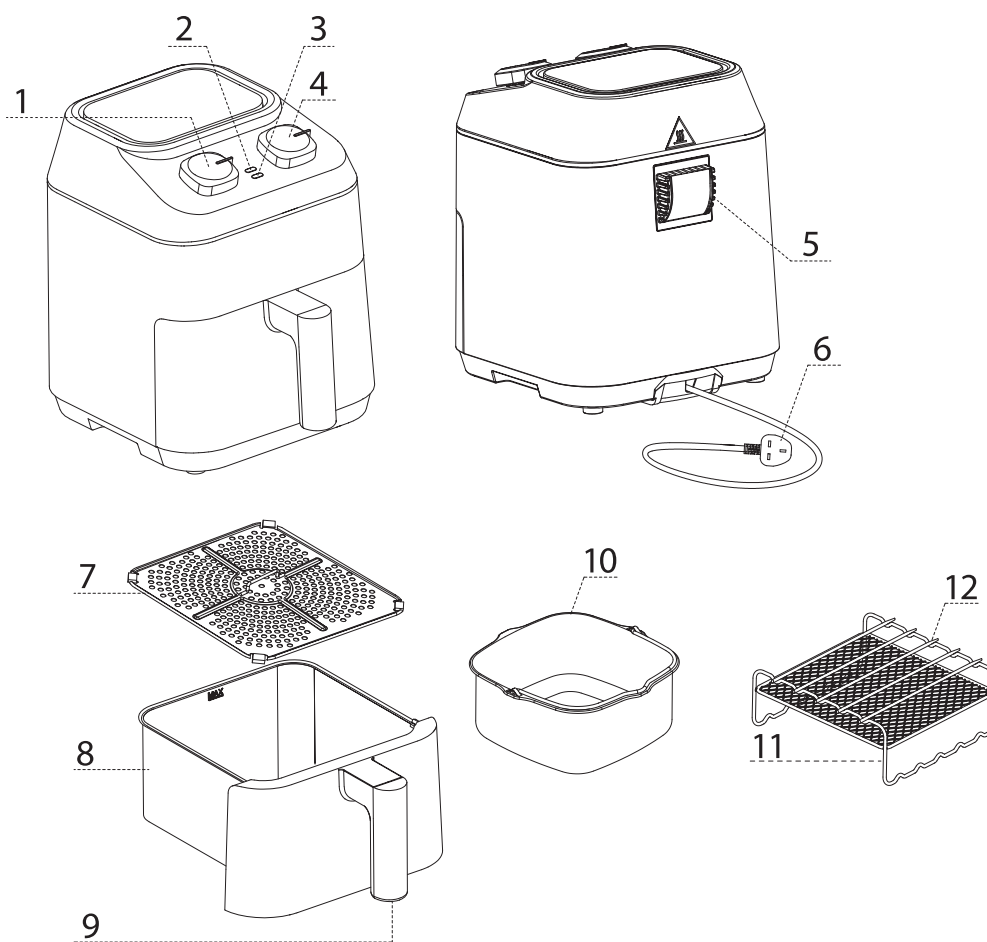

(Product images are for illustrative purpose only and may differ from the actual product.)

- | | |
|----------------------|------------------------|
| 1. Thermostat knob | 7. Fryer basket rack |
| 2. Heating indicator | 8. Fryer basket |
| 3. Power indicator | 9. Fryer basket handle |
| 4. Timer knob | 10. Baking pan |
| 5. Exhaust vent | 11. Grill rack |
| 6. Power plug | 12. Skewers |

5. Before first use

1. Remove all the packaging materials and stickers from the appliance.
2. Thoroughly clean all the accessories, rinse them and wipe them dry.
3. Clean the surface and cavity of the appliance with a wrung soft cloth, then wipe it dry.

6. Operation Instructions

6.1 Basic Operation

1. Pull out the fryer basket and place the fryer basket rack into the fryer basket.
2. Place food on the fryer basket rack and must not exceed the MAX level of the fryer basket.
3. Push the fryer basket back to the main body until pressed tightly, otherwise the appliance will not heat up.
4. Plug in the appliance, the power indicator will turn on.
5. Turn the thermostat knob to set the cooking temperature. The temperature setting range is 80°C - 200°C.
6. Turn the timer knob to set the cooking time. The timer range is 0-60 minutes.
7. Once set the cooking temperature and time, the heating indicator will turn on.
8. When the cooking time is finished, the timer knob will back to "0" position and the appliance will have a signal sound. Should turn the thermostat knob to "0" to switch off the appliance.
9. After use, unplug the appliance from the power socket.

6.2 Usage method of accessories

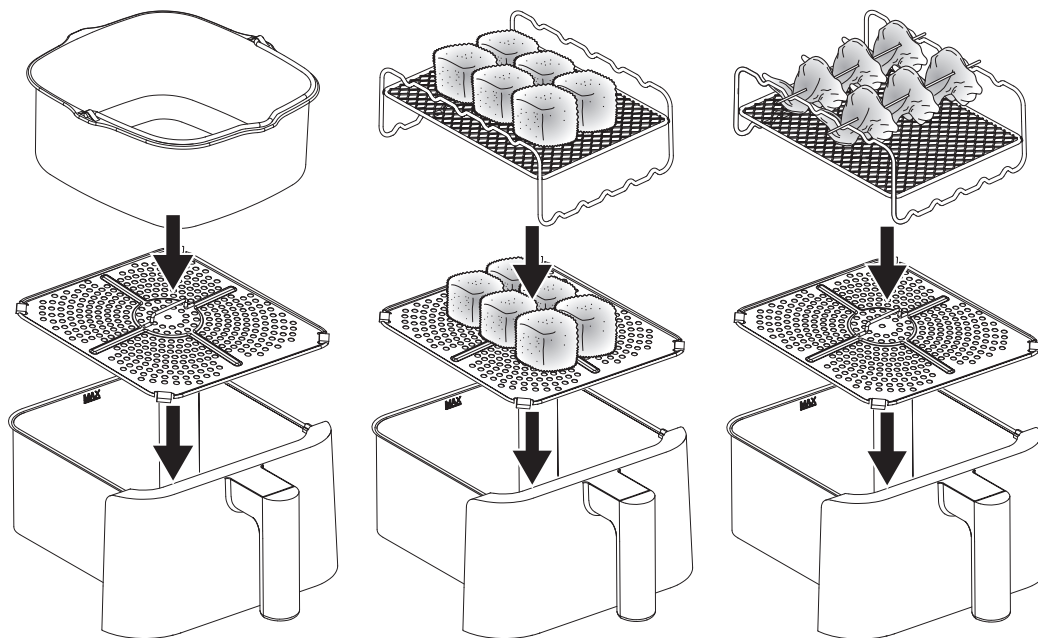

1. Baking pan - Put the food in the baking pan, and then put the baking pan on the fryer basket rack.
2. Grill rack - Place the lower handle of grill rack upwards on the fryer basket rack. Food can be placed on the upper and lower levels of the grill rack.
3. Skewers - Put the higher handle of grill rack upwards on the fryer basket rack, and then put the skewered food onto the grill rack.

6.3 Notes on use:

1. Before cooking, preheat 5 minutes that can achieve a better cooking result. When preheat, the appliance may have some smoke, smell and noise, which is normal.
2. The cooking time is varied with different food temperature, types, quantity, shape, etc. Must adjust it according to the actual cooking condition.
3. Always pay attention to the food during cooking to avoid overcooking. Do not cook light ingredients, it may be blown and caused malfunction and fire.
4. To minimize the production of acrylamide, do not cook food at too high temperature and for too long.
5. During the cooking, turn food if needed to have more even cooking result.
6. Frozen food may take longer time to cook, must adjust the cooking time and temperature according to the actual cooking condition.
7. When cooking, water vapor may condense around the appliance. This is because water evaporates from the food which is normal.
8. To adjust the appliance temperature, the heating elements will be off temporarily when the appliance reaches the preset temperature and on again when the temperature of appliance declines. The temperature setting is subject to the manufacture specification.
9. There may be noise when the appliance is operating, it is due to heat expansion of material and food, and it does not indicate any malfunction.

7. Troubleshooting

Problem	Cause	Solution
1. The appliance cannot operate.	– The appliance is not plugged or it is plugged insecurely.	– Re-insert the plug into the socket.
	– Have not turn the timer knob to set the cooking time.	– Turn the timer knob to set the cooking time.
	– The fryer basket is not installed well.	– Push the fryer basket back to the main body until pressed tightly.
2. The food cooked unevenly.	– The food is overlapped.	– During cooking, turn food to have more even cooking result.
3. The food is not done.	– Too much food.	– Reduce the food quantity.
	– The cooking temperature is too low.	– Adjust a higher cooking temperature to cook.
	– The cooking time is too short.	– Put the food into the appliance and cook again.

4. The fryer basket cannot push back to the appliance.	- Too much food filled in the fryer basket which is beyond the MAX level.	- Reduce the amount of food which should not exceed the MAX level.
	- The fryer basket is placed incorrectly.	- Push the fryer basket back to the main body until pressed tightly.
5. White smoke comes out of the appliance.	- The cooking food is too greasy.	- Do not cook greasy food.

If the above solutions cannot fix the problem, stop using immediately and contact Shun Hing Electric Service Centre Ltd to check and repair.

8. Special Avowal

1. The content in the operation manual has been checked. Our company reserves the hermeneutic power to any printing errors or misunderstanding on the content.
2. If there are technical improvements on the appliance, the operation manual will be updated in new version without prior notice. The product appearance and specification are subject to the manufacturer information.
3. The e-copy of user manual can be sent by e-mail on requested. For enquiries, please call Shun Hing Electric Works & Engineering Co., Ltd. hotline at 2861 2767.

9. After Sales Service

Shun Hing Electric Works & Engineering Co., Ltd. ("The Company") authorizes Shun Hing Electric Service Centre Ltd. ("SHESC") (collectively "Shun Hing") to offer one year warranty service to the product commencing from the date of purchase invoice or redemption voucher. SHESC reserves the right to change the warranty terms without prior notice. For details of the warranty terms, you can refer to our website.



信興電工工程有限公司

SHUN HING ELECTRIC WORKS AND ENGINEERING CO., LTD.

辦公室：香港九龍尖沙咀東部麼地道67號半島中心9樓909-912室

電話：2861 2767

圖文傳真：2865 6706

網址：<http://www.rasonic.com>

電郵：shew@shunhinggroup.com

Office: Room 909-912,9/F., Peninsula Centre, 67 Mody Road, Tsimshatsui East, Kowloon, H.K.

Tel: 2861 2767

Fax: 2865 6706

Website: <http://www.rasonic.com>

E-mail: shew@shunhinggroup.com

保養及維修 Maintenance and Repair Service:

信興電器服務中心有限公司

SHUN HING ELECTRIC SERVICE CENTRE LTD.

香港新界葵涌勝耀街2號信興中心11樓

服務熱線：2406 5666

傳真號碼：2408 0316

網址：<http://www.shesc.com/zh>

11/F, Shun Hing Centre, 2 Shing Yiu Street, Kwai Chung, N.T., H.K.

Service Hotline: 2406 5666

Fax No.: 2408 0316

Website: <http://www.shesc.com/en>

客戶服務中心：

香港新界葵涌勝耀街2號信興中心1樓

九龍佐敦佐敦道23-29號新寶廣場20樓

香港天后琉璃街7號柏景中心22樓

澳門慕拉士大馬路193-199號南嶺工業大廈5樓1座

有關最新之香港及澳門客戶服務中心資料，請參閱信興服務中心網址：www.shesc.com。

Customer Service Centres:

1/F, Shun Hing Centre, 2 Shing Yiu Street, Kwai Chung, N.T., H.K.

20/F, Sino Cheer Plaza, 23-29 Jordan Road, Jordan, Kowloon, H.K.

22/F, Parkview Centre, 7 Lau Li Street, Tin Hau, H.K.

Avenida de Venceslau de Morais, No.193-199, 5 andar - I, Edf. Industrial Nam Leng, Macau

For the latest information of Hong Kong and Macau service center, please visit www.shesc.com.